

MECHANICAL FAUCETS

510-GVB613L12XKCAB



a Geberit company

Product Type

Features & Specifications

- 1.0 GPM @ 60 PSI Spray Valve
- 2-3/8" Vandal Proof Lever Handles
- Ceramic Cartridge with Integrated Check Valve 1/4 Turn Operating Cartridges
- 3/8" Offset Inlet Supply Arm
- Secondary Control Valve
 - 12" L Type Swing Spout
 - Full Flow Outlet
 - 2-3/8" Vandal Proof Lever Handles
 - Quatum Compression Operating Cartridges
- 2 5/16" Diameter Slip Flange
- 23" Riser with Spring Guide
- 44" Flexible Stainless Steel Hose with Insulated Handle
- E23JKABCP In-line back flow preventer to prevent the flow of contaminated water back into the potable water supply
- Pipe Strap and Hook Assembly
- Atmospheric Vacuum Breaker, Not Intended for Continuous Pressure Applications
- ECAST® design provides durable construction with total lead content equal to or less than 0.25% by weighted average

Performance Specification

- Rated Operating Pressure: 20-125 PSI
- Rated Operating Temperature: 40-140°F

Warranty

- Lifetime Limited Faucet Warranty
- 5-Year Limited Cartridge Warranty
- 1-Year Limited Finish Warranty

Codes & Standards

- ASME A112.18.1/CSA B125.1
- Certified to NSF/ANSI 61, Section 9 by CSA
- California Health and Safety Code 116875 (AB1953-2006)
- Vermont Bill S.152
- NSF/ANSI 372 Low Lead Content

Job Name _____

Item Number _____

Section/Tag _____

Model Specified _____

Architect _____

Engineer _____

Contractor _____

Submitted as Shown Submitted with Variations

Date _____



ECAST

ECAST products are intended for installation where state laws and local codes mandate lead content levels or in any location where lead content is a concern.



2100 South Clearwater Drive
Des Plaines, IL
P: 847/803-5000
F: 847/803-5454
Technical: 800/TEC-TRUE
www.chicagofaucets.com

Architect/Engineer Specification

Chicago Faucets No. 510-GVB613L12XKCAB, Pre-Rinse Fitting with 613-A Adapta-Faucet, wall-mounted with adjustable arms for 7-1/4" - 8-3/4" centers. Chrome plated. Water conserving pre-rinse spray valve, 1.0 GPM @ 60 PSI. 2-3/8" metal, vandal-proof, lever handles with sixteen-point, tapered broach and secured blue and red index buttons. Ceramic quarter-turn cartridge with integrated check valve, features square, tapered stem. 3/8" offset inlet supply arm with 1/2" NPT female thread inlet. 2-5/16" diameter slip flange. 23" riser with spring guide. 44" flexible stainless steel hose with insulated handle. E23JKABCP in-line back flow preventer to prevent the flow of contaminated water back into the potable water supply. Pipe strap and hook assembly. NOTE: Atmospheric vacuum breaker is NOT intended for continuous pressure applications. ECAST™ construction with less than 0.25% lead content by weighted average. Full-flow Quixtop outlet with single-screen design. 2-3/8" metal, vandal-proof lever handle with sixteen-point, tapered broach and secured, white index button. Quatern^a rebuildable compression cartridge, opens and closes 90°, closes with water pressure, features square, tapered stem. This product is tested and certified to industry standards: ASME A112.18.1/CSA B125.1, Certified to NSF/ANSI 61, Section 9 by CSA, California Health and Safety Code 116875 (AB1953-2006), Vermont Bill S.152, and NSF/ANSI 372 Low Lead Content.

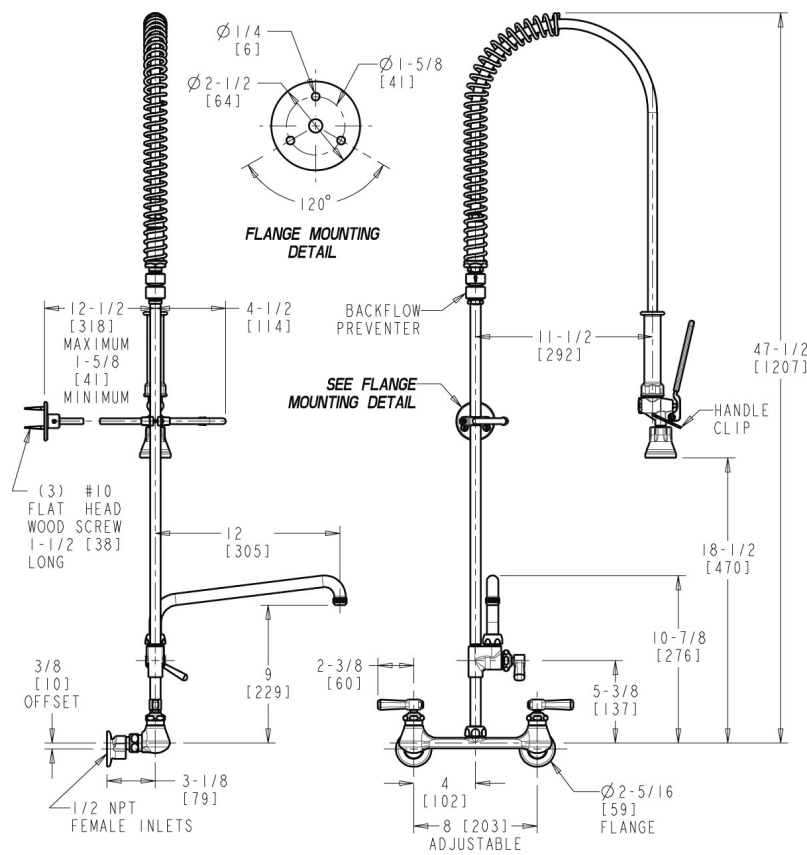

Operation and Maintenance

Installation should be in accordance with local plumbing codes. Flush all pipes thoroughly before installation. After installation, remove spout outlet or flow control and flush faucet thoroughly to clear any debris. Care should be taken when cleaning the product. Do not use abrasive cleaners, chemicals or solvents as they can result in surface damage. Use mild soap and warm water for cleaning and protecting the life of Chicago Faucet products. For specific operation and maintenance refer to the installation instructions and repair parts documents that are located at www.chicagofaucets.com.

Chicago Faucets, member of the Geberit Group, is the leading brand of commercial faucets and fittings in the United States, offering a complete range of products for schools, laboratories, hospitals, office buildings, food service, airports and sport facilities. Call 1.800.TECTRUE or 1.847.803.5000 Option 1 for installation or other technical assistance.

